



A Precision Wave Guide Attenuator Which Obeys a Mathematical Law

FOR about a year and a half -hp- has been manufacturing a new type of direct-reading precision wave guide attenuator known as a rotary attenuator*. This device is distinguished by the fact that its attenuation follows a predictable, mathematical law not related to frequency. Other than the cutoff attenuator which has several disadvantages in wave guide use, this rotary attenuator is generally considered to be the most accurate attenuator available for wide band microwave applications.

See Also:
"A New Phase Shifter," p. 3

The attenuator has a calibrated range of 0 to 50 db which is accurate within 2% of the db reading at any frequency in a wave guide band. This accuracy is obtained directly from the calibrated dial; no calibration charts are required. The VSWR of the attenuator is less than 1.15 and the insertion loss is less than 1 db.

Until recently, the rotary attenuator has been produced only in 8.2-12.4 kmc size wave guide. It is now being produced in five wave guide sizes

which collectively cover the range from 3.95 to 18 kmc.

Basically, the attenuator consists of three sections of wave guide in tandem. In each section a resistive film is placed across the guide as shown in Fig. 2. The middle section is a short length of round guide which is free to rotate axially with respect to the two fixed end sections. The end sections are rectangular-to-round wave guide transitions in which the resistive films are normal to the E field of the applied wave. The construction is symmetrical and the device is bi-directional.

When all films are aligned, the E field of the applied wave is normal to all films. No current then flows in the films, and no attenuation occurs. If the center film is now rotated to some angle θ , the E field can be considered to be split into two components: $E \sin \theta$ in the plane of the film, and $E \cos \theta$ at right angles to it. The $E \sin \theta$ component will be absorbed by the film, while the $E \cos \theta$ component, oriented at an angle θ with respect to the original wave, will be passed unattenuated to the third section. When it encounters the third film, the $E \cos \theta$ component will be split into two components. The $E \cos \theta \sin \theta$ component will be absorbed, and the $E \cos^2 \theta$ component will emerge at the same orientation as the original wave.

The attenuation is thus ideally proportional only to the angle to which the center film is rotated and is completely independent of frequency. In db terms the attenuation is equal to $40 \log \cos \theta$.

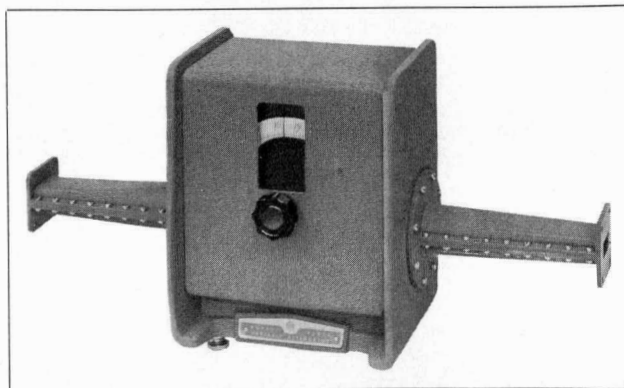

Fig. 1. -hp- Model 382A Variable Attenuator has been designed in five wave guide sizes which collectively cover 3.95 to 18 kmc range. Units are calibrated to 50 db but can usually be used to 70 db.

*An attenuator of this type is described by G. C. Southworth, "Principles and Applications of Waveguide Transmission," p. 374, D. Van Nostrand, New York. Inventor of the attenuator is understood to be the late A. E. Bowen.

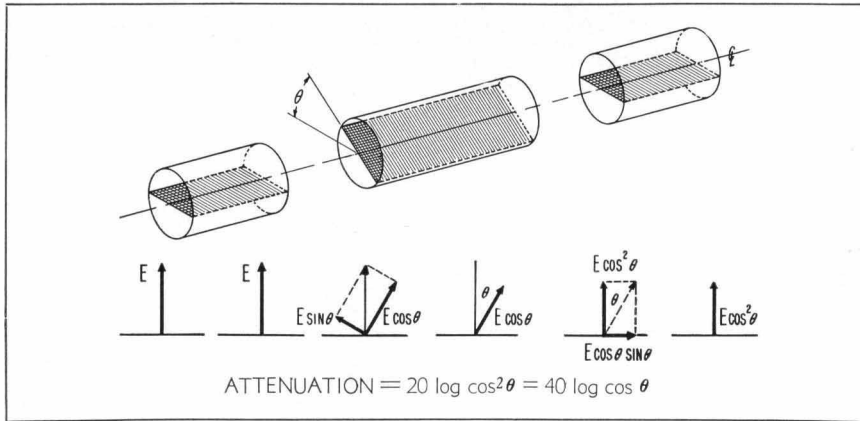

Fig. 2. Functional drawing indicating operating principle of Model 382A Variable Attenuator.

Performance of a typical attenuator in the 8.2-12.4 kmc range is shown in Figs. 3 to 6. Performance of the attenuators in other frequency ranges is comparable. The insertion loss shown in Fig. 4 is the loss encountered with the attenuator set for zero attenuation. Rated value for this loss is 1 db maximum.

Phase shift variations in the attenuator are very small. For settings between 0 and 40 db variations in phase shift are less than one degree. This small value makes the attenuators valuable in applications where it is important that applied power be varied independently of phase. Such requirements occur, for example, in measurements on multi-element antennas where the drive to the various elements must be varied to obtain the desired antenna pattern. By inserting rotary attenuators in series with the appropriate elements, the excitation can be varied over wide ranges.

Since the attenuation is virtually unaffected by frequency, these attenuators, besides being valuable in general-purpose applications, offer a solution to the problem of providing signal generators with precision attenuators at frequencies where cut-off attenuators have excessive slope. By combining two of the attenuators in series, precision attenuations of up to 100 db can be obtained. One or two of the attenuators can also be used with klystron signal sources to form bench type signal generators suitable for many purposes.

Maximum attenuation of the attenuator exceeds the 50 db calibrated range by at least 20 db, but the characteristics in this range are not controlled. Theoretically, the attenuator is capable of very high attenuations. In practice this property is modified by the fact that the resistive film in the middle section can not completely absorb the $E \sin \theta$ component. Hence, a small leakage component is passed to the output. For high attenuations above 50 db, the leakage component begins to approach the magnitude of the desired output of the attenuator. Ultimate attenuation of the device thus becomes limited by the attenuation of the center rotating film which is 70 db or more. Fig. 6 shows that at 90° rotation the attenuation for any frequency in the rated range is approximately this value.

It is interesting to note that the accuracy of the attenuator does not

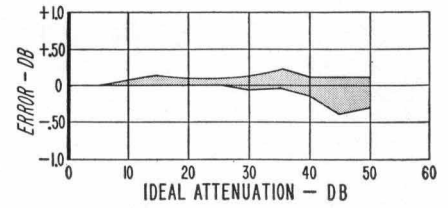

Fig. 3. Plot of typical maximum error encountered at any rated frequency at various attenuation settings.

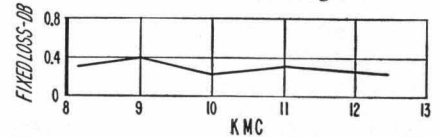

Fig. 4. Plot of typical insertion loss obtained with 8.2-12.4 kmc attenuator set for zero attenuation.

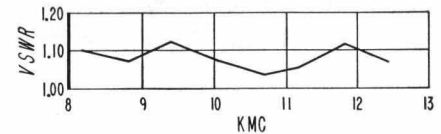

Fig. 5. Plot of typical VSWR of 8.2-12.4 kmc attenuator.

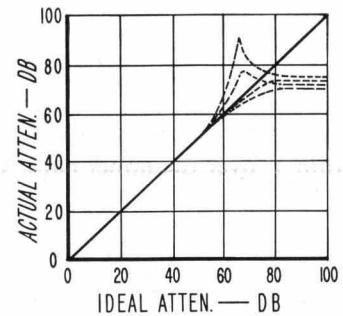

Fig. 6. Plot of typical attenuation characteristic of rotary attenuator.

depend on the stability of the resistive films: as long as their attenuation is high and remains high, performance is not affected. Accurate centering of the films in the guides is obtained by clamping them between machined halves of the guide.

—B. P. Hand

SPECIFICATIONS					
-hp-					
MODEL 382A VARIABLE ATTENUATOR					
MODEL:	G382A	J382A	H382A	X382A	P382A
FREQUENCY RANGE (KMC):	3.95-5.85	5.3-8.2	7.0-10.0	8.2-12.4	12.4-18.0
WAVEGUIDE SIZE:	2" x 1"	1 1/2" x 3/4"	1 1/4" x 5/8"	1" x 1/2"	0.702" x 0.391"
POWER-HANDLING CAPACITY, WATTS, AVERAGE, CONTINUOUS DUTY:	15	10	10	10	5
SIZE, LENGTH:	31 5/8"	25"	19 7/8"	15 1/2"	12 1/8"
HEIGHT:	9 3/4"	8"	8"	7 3/4"	7 3/4"
DEPTH:	7-3/16"	6 1/4"	6 1/4"	4 1/2"	4 1/2"
WEIGHT, NET:	25	12	10	5	5
SHIPPING:	75	32	30	19	18
PRICE:	\$450.00	\$300.00	\$300.00	\$250.00	\$250.00
CALIBRATED RANGE: 0 - 50 db.					
ACCURACY: $\pm 2\%$ of the reading in db, or 0.1 db, whichever is greater. Includes calibration error plus frequency error.					
ATTENUATION AT ZERO SETTING: Less than 1 db. Calibration data available on request.					
PHASE SHIFT: Variation less than 1° for all attenuation settings to 40 db.					
VSWR: Less than 1.15 entire range of attenuation and frequency.					
Prices f.o.b. Palo Alto, California Data subject to change without notice.					

A New Precision Wave Guide Phase Shifter

IN MANY microwave measurements, especially those that involve detection of nulls such as in antenna phase contour measurements, a precision phase shifter is a valuable device. For such applications a new wave guide phase shifter which is direct-reading in phase shift to a high accuracy has been developed. This device operates over the complete 8.2-12.4 kilomegacycle range and will either advance or retard the phase of its output wave by any angle up to a full 360°. In fact, the phase can be changed continuously through any number of cycles if the tuning control is rotated continuously. The phase shift occurs with respect to an arbitrary fixed phase shift similar to that occurring in an equal length of wave guide. The device is accurate within 2° over the lower half of its frequency range and within 3° over the upper half. A desired phase shift is obtained to this accuracy merely by setting the calibrated control dial.

Figs. 2 and 3 show, respectively, a cutaway drawing of the phase shifter and a functional drawing of its essential operating parts. It consists basically of three sections of round wave guide, each of which contains a plate of dielectric material. At the extreme ends of the device are rectangular-to-round transition sections. The middle round wave guide section is free to rotate while all other sections are fixed.

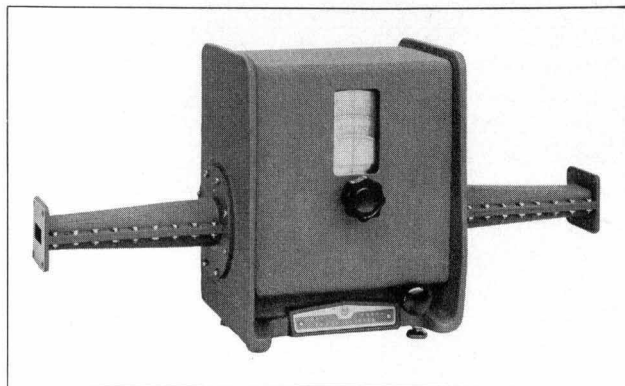

Fig. 1. New *hp*-Model X885A Wave Guide Phase Shifter is direct-reading in phase shift from 0 to + or - 360°, operates over 8.2-12.4 kmc range.

The general scheme of operation of the device¹ is that the first round section converts an applied wave to a circularly polarized wave rotating in a clockwise direction. The middle section converts the clockwise-rotating wave to a counterclockwise-rotating wave and delays the wave in proportion to the angular position of the section. The third section restores the wave to its original vertical polarization, but the wave now has a phase shift determined by the angle of the middle section.

When a dominant-mode wave is applied at the left, it will give at the input of the first round section the customary $TE_{1,1}$ electric field pattern shown in Fig. 3. This wave is termed a linearly polarized wave because its E vector at the center of the guide is always in a single plane, which in this case is the vertical plane. As this wave traverses the first round section, it is influenced by the dielectric plate which is positioned in the section at an angle of 45° to the E vector as shown in Fig. 4. If the E vector is considered to be composed of two components located at 45° to it as shown, this plate is designed to delay the component in the plane of the plate by an angle of 90° more than the component normal to the plate. At the output of the section, then, the undelayed component will lead the delayed

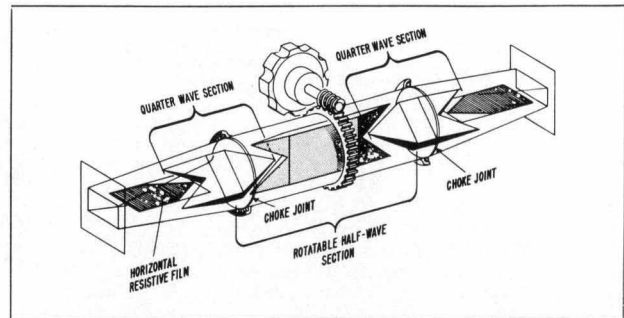

Fig. 2. Phantom view of *hp*-Model X885A Phase Shifter showing relation of fixed 90° differential sections, the 180° rotatable section, and fixed end films which absorb horizontally-polarized output component.

component by 90° so that the resultant of these two components will be a circularly polarized wave rotating in a clockwise direction. This can be determined by forming the resultant of the two components in Fig. 4 as they progress toward the right.

When the circularly-polarized wave produced by the 90° section traverses the middle round section, it is influenced by a plate which is twice as long as the plates in the first and third sections. This plate will thus delay any component in its plane by 180° more than a component normal to the plate. This has the incidental effect of converting a clockwise-rotating wave into a counterclockwise-rotating wave. But it can also be shown that when the 180° plate is rotated through any given physical angle the time-phase of the resultant output from the section changes by twice that angle. Thus, for a full 360° rotation of the 180° plate the applied wave will be changed by 720°.

The dial is provided with a 2:1

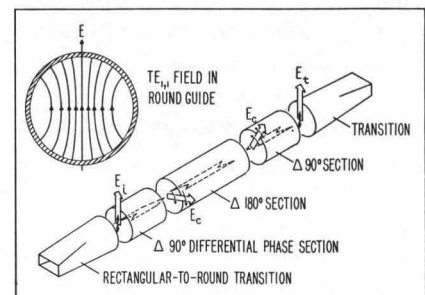

Fig. 3. Functional drawing of phase shifter illustrating polarization of electric field as it traverses various sections.

¹ A. Gardner Fox, "An Adjustable Wave-Guide Phase Changer," Proceedings of the I.R.E., Vol. 35, No. 12, December, 1947.

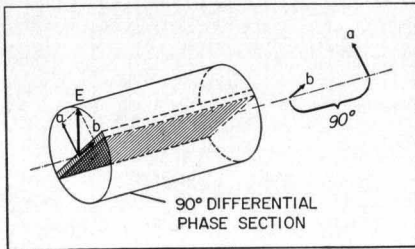
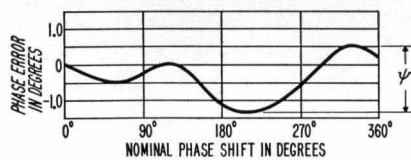

Fig. 4. Schematic drawing illustrating how 90° dielectric plate delays one component of electric field. Resultant of a and b at output of section is circularly polarized in clockwise direction.

gear ratio between it and the 180° section. With this arrangement one degree of rotation of the dial corresponds to one degree of phase shift. The dial is provided with two scales, one of which reads counterclockwise from 0 to +360 electrical degrees while the other reads clockwise from 0 to -360 electrical degrees. If the dial is continuously rotated in one direction or the other, however, the wave will be continuously advanced or retarded, as the case may be.

The third round section of the phase shifter is identical to the first and has the property of converting a counterclockwise-rotating wave to a linearly-polarized wave. The third section thus restores the original polarization of the wave, which is then passed through the final transition section to the output.

Theoretically, the plates will pro-



(a)

Typical phase error obtained as function of dial setting at 12.4 kmc.

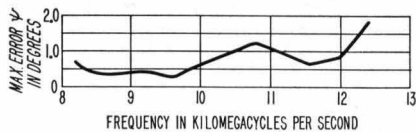

(b)

Typical maximum phase error obtained over rated frequency range. Plotted values are maximum peak-to-peak values of a series of curves like that in (a) above.

Fig. 5. Error curves for typical phase shifter.

duce their nominal differential phase shifts at only one frequency. To make this phase shift more nearly constant at all frequencies within the usual 8.2-12.4 kmc operating range of 1" x 1/2" wave guide, the sections are compensated with recesses and grooves. In this way the differential phase shift is made as constant as possible, although the sections by themselves will still exhibit an error of some ±5° over the band. It has been shown², however, that lack of an exact 90° or 180° phase shift in the differential sections produces only second order phase errors at the output of the device. It is therefore possible for the calibration of the phase shifter as a whole to exhibit only a fraction of the error occurring in the differential phase shift of an individual section. While imperfections in the differential phase shifts of the sections give rise to horizontally-polarized components which could otherwise cause significant phase errors, these are attenuated by horizontal resistive films (Fig. 2) located in the transition sections. The emerging error components are thus second-order components.

Fig. 5 shows performance typical of one of the phase shifters with respect to accuracy. The error is plotted in Fig. 5 (a) with regard to the sense in which it occurs, i.e., as + or - increments from the setting of the dial. It should be noted, however, that the error obtained in use is the difference between errors for the appropriate points on the error curve. Thus, the maximum error for the case illustrated in Fig. 5 (a) would be obtained when the dial was moved from a setting of 200° to a setting of 330° and would be 1.9° in this case. This is the quantity termed maximum error in the specifications. It should be further noted that the error for small changes in the settings

² Alan J. Simmons, "Errors in a Microwave Rotary Phase Shifter," Correspondence to the "Proceedings of the I.R.E.," Vol. 40, No. 7, July, 1952, p. 869.

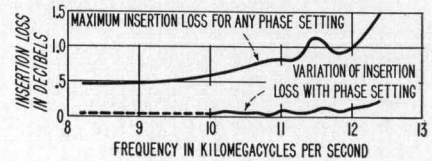

Fig. 6. Plots of insertion loss typical of phase shifter.

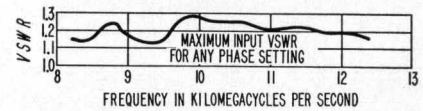

Fig. 7. Plot of typical maximum VSWR as a function of frequency.

of the phase shifter is also small. This gives rise to a rating of less than 10% error for changes in setting of less than 20°. For convenience in using the device, the dial is provided with a lock and friction clutch so that the dial can be zeroed at any desired position.

Typical insertion loss and VSWR characteristics of the new phase shifter are shown in Figs. 6 and 7.

Designs have also been established for 5.3-8.2 and 12.4-18 kmc models which will soon be in production.

—E. F. Barnett

SPECIFICATIONS

-hp-

MODEL X885A WAVEGUIDE PHASE SHIFTER

PHASE RANGE: -360 to +360 electrical degrees. Can be rotated continuously through any number of cycles.

FREQUENCY RANGE: 8.2 kmc to 12.4 kmc.

DIAL: Direct-reading, 2 divisions per degree.

ACCURACY: For any phase difference: 2° from 8.2 to 10 kmc; 3° from 10 to 12.4 kmc; 10% for phase differences less than 20°.

OUTPUT LEVEL: Varies less than 0.35 db full phase range at a single frequency.

MAXIMUM INSERTION LOSS: Less than 1 db from 8.2 to 10 kmc; less than 2 db from 10 to 12.4 kmc.

VARIATION OF INSERTION LOSS WITH PHASE SETTING AT A FIXED FREQUENCY: Less than 0.3 db from 8.2 to 10 kmc; less than 0.4 db from 10 to 12.4 kmc.

VARIATION OF INSERTION LOSS WITH FREQUENCY: About 1 db from 8.2 to 12.4 kmc.

VSWR: 1.35 maximum, full frequency range.

POWER-HANDLING CAPACITY: Approximately 2 watts.

SIZE: 15 1/2" long, 7 3/4" high, 4 1/2" deep.

WEIGHT: 5 lbs.; shipping weight approx. 19 lbs.

WAVEGUIDE: 1" x 1/2", flat cover flanges.

PRICE: \$250.00 f.o.b. Palo Alto, California.

Data subject to change without notice.